



## Inhaltsverzeichnis

1	MeoLock - zweiteilig – MeoClassic Implantat .....	2
2	MeoLock - zweiteilig – MeoTulip Implantat .....	3
3	MeoLock - zweiteilig – Verbindungsschraube .....	5
4	MeoLock - zweiteilig – 1.4 Sechskantinstrument ISO-Schaft • Funktionsdarstellung • .....	6
5	MeoLock - zweiteilig – 1.4 Sechskantinstrument HS/RS • Funktionsdarstellung • .....	7
6	MeoLock - zweiteilig – Modellanalog Standard .....	8
7	MeoLock - zweiteilig – Modellanalog CAD/CAM .....	9

## 1 MEOLOCK - ZWEITEILIG – MEOCLASSIC IMPLANTAT

Produktbeschreibung	REF	MeoLock - zweiteilig GH 1mm	MeoLock - zweiteilig GH 2mm	MeoLock - zweiteilig GH 3mm	MeoLock - zweiteilig GH 4mm	MeoLock - zweiteilig GH 5mm	MeoLock - zweiteilig GH 6mm
		S-040-500201	S-040-500202	S-040-500203	S-040-500204	S-040-500205	S-040-500206
MeoClassic Ø3,5x8mm	S-001-350080	✓	✓	✓	✓	✓	✓
MeoClassic Ø3,5x10mm	S-001-350100	✓	✓	✓	✓	✓	✓
MeoClassic Ø3,5x12,5mm	S-001-350125	✓	✓	✓	✓	✓	✓
MeoClassic Ø3,5x15mm	S-001-350150	✓	✓	✓	✓	✓	✓
MeoClassic Ø3,8x8mm	S-001-380080	✓	✓	✓	✓	✓	✓
MeoClassic Ø3,8x10mm	S-001-380100	✓	✓	✓	✓	✓	✓
MeoClassic Ø3,8x12,5mm	S-001-380125	✓	✓	✓	✓	✓	✓
MeoClassic Ø3,8x15mm	S-001-380150	✓	✓	✓	✓	✓	✓
MeoClassic Ø4,2x8mm	S-001-420080	✓	✓	✓	✓	✓	✓
MeoClassic Ø4,2x10mm	S-001-420100	✓	✓	✓	✓	✓	✓
MeoClassic Ø4,2x12,5mm	S-001-420125	✓	✓	✓	✓	✓	✓
MeoClassic Ø4,2x15mm	S-001-420150	✓	✓	✓	✓	✓	✓
MeoTulip Ø4,8x6mm	S-001-480060	✓	✓	✓	✓	✓	✓
MeoClassic Ø4,8x8mm	S-001-480080	✓	✓	✓	✓	✓	✓
MeoClassic Ø4,8x10mm	S-001-480100	✓	✓	✓	✓	✓	✓
MeoClassic Ø4,8x12,5mm	S-001-480125	✓	✓	✓	✓	✓	✓
MeoClassic Ø4,8x15mm	S-001-480150	✓	✓	✓	✓	✓	✓
MeoTulip Ø6,0x6mm	S-001-600060	✓	✓	✓	✓	✓	✓
MeoClassic Ø6,0x8mm	S-001-600080	✓	✓	✓	✓	✓	✓
MeoClassic Ø6,0x10mm	S-001-600100	✓	✓	✓	✓	✓	✓

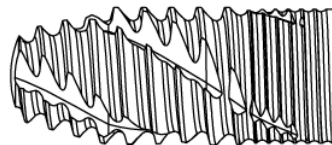

MeoClassic - Implantat

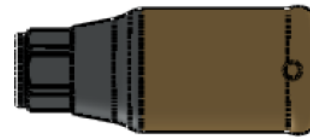

MeoLock - zweiteilig

← MEOLOCK - ZWEITEILIG – MEOCLASSIC IMPLANTAT

## 2 MEOLOCK - ZWEITEILIG – MEOTULIP IMPLANTAT

Produktbeschreibung	REF	MeoLock - zweiteilig GH 1mm	MeoLock - zweiteilig GH 2mm	MeoLock - zweiteilig GH 3mm	MeoLock - zweiteilig GH 4mm	MeoLock - zweiteilig GH 5mm	MeoLock - zweiteilig GH 6mm
		S-040-500201	S-040-500202	S-040-500203	S-040-500204	S-040-500205	S-040-500206
MeoTulip Ø3,5 x 8mm	S-002-350080	✓	✓	✓	✓	✓	✓
MeoTulip Ø3,5 x 10mm	S-002-350100	✓	✓	✓	✓	✓	✓
MeoTulip Ø3,5 x 12,5mm	S-002-350125	✓	✓	✓	✓	✓	✓
MeoTulip Ø3,8 x 8mm	S-002-380080	✓	✓	✓	✓	✓	✓
MeoTulip Ø3,8 x 10mm	S-002-380100	✓	✓	✓	✓	✓	✓
MeoTulip Ø3,8 x 12,5mm	S-002-380125	✓	✓	✓	✓	✓	✓
MeoTulip Ø4,2 x 8mm	S-002-420080	✓	✓	✓	✓	✓	✓
MeoTulip Ø4,2 x 10mm	S-002-420100	✓	✓	✓	✓	✓	✓
MeoTulip Ø4,2 x 12,5mm	S-002-420125	✓	✓	✓	✓	✓	✓
MeoTulip Ø4,8 x 6mm	S-002-480060	✓	✓	✓	✓	✓	✓
MeoTulip Ø4,8 x 8mm	S-002-480080	✓	✓	✓	✓	✓	✓

# MEOLOCK - ZWEITEILIG

KOMPATIBEL / EIGENSCHAFTEN

MEOLOCK - ZWEITEILIG

VERSION: 01

Seite 4 von 9



MeoTulip Ø4,8 x 10mm	S-002-480100	✓	✓	✓	✓	✓	✓
MeoTulip Ø4,8 x 12,5mm	S-002-480125	✓	✓	✓	✓	✓	✓
MeoTulip Ø6,0 x 6mm	S-002-600060	✓	✓	✓	✓	✓	✓
MeoTulip Ø6,0 x 8mm	S-002-600080	✓	✓	✓	✓	✓	✓
MeoTulip Ø6,0 x 10mm	S-002-600100	✓	✓	✓	✓	✓	✓

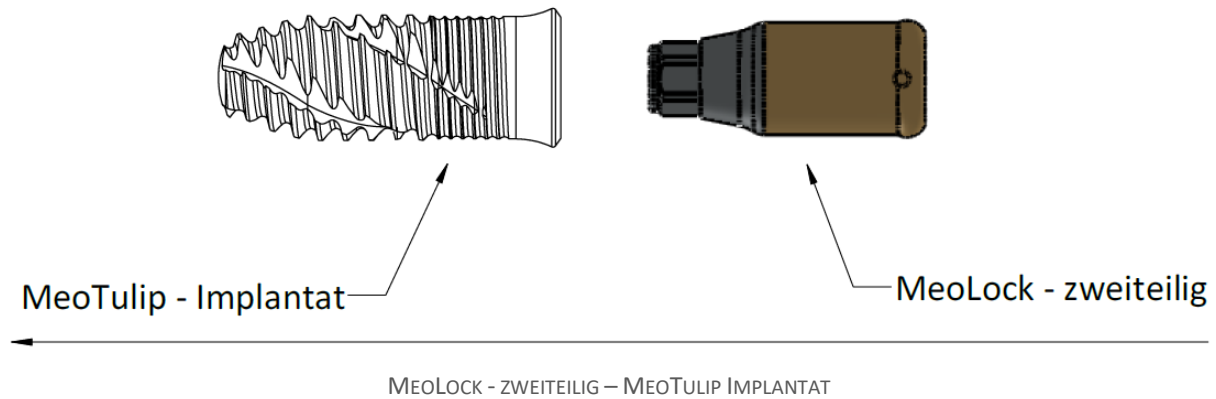

## 3 MEOLOCK - ZWEITEILIG – VERBINDUNGSSCHRAUBE (LILA)

Produktbeschreibung	REF	MeoLock - zweiteilig GH 1mm	MeoLock - zweiteilig GH 2mm	MeoLock - zweiteilig GH 3mm	MeoLock - zweiteilig GH 4mm	MeoLock - zweiteilig GH 5mm	MeoLock - zweiteilig GH 6mm
		S-007-504001	S-007-504002	S-007-504003	S-007-504004	S-007-504005	S-007-504006
Verbindungsschraube (lila)	A-007-055055	✓	✓	✓	✓	✓	✓

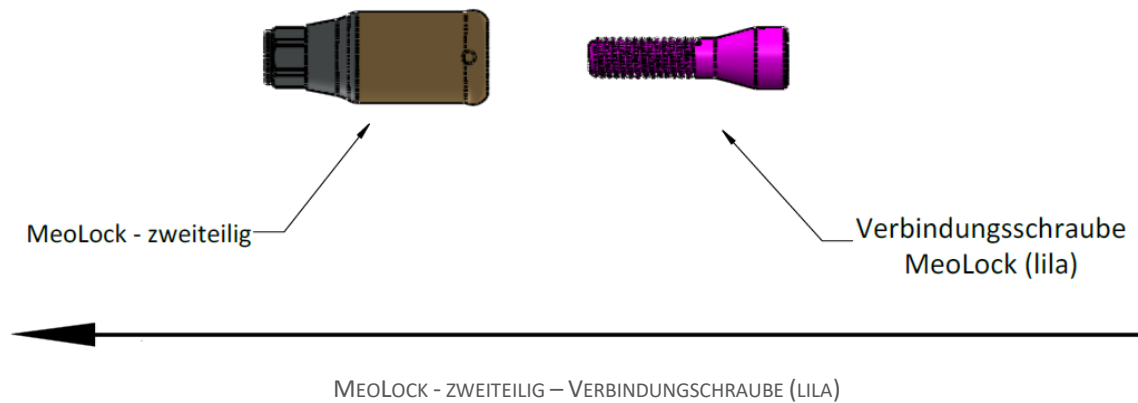

## 4 MEOLOCK - ZWEITEILIG – 1.4 SECHSKANTINSTRUMENT ISO-SCHAFT

### • FUNKTIONSDARSTELLUNG •

mit Verbindungsschraube (lila)

Produktbeschreibung	REF	Verbindungs- schraube (lila)
		A-007-055055
1.4 Sechskantinstrument ISO-Schaft - 45mm	A-015-099077	✓
1.4 Sechskantinstrument ISO-Schaft - 28mm	A-015-099088	✓
1.4 Sechskantinstrument ISO-Schaft - 24mm	A-015-099099	✓

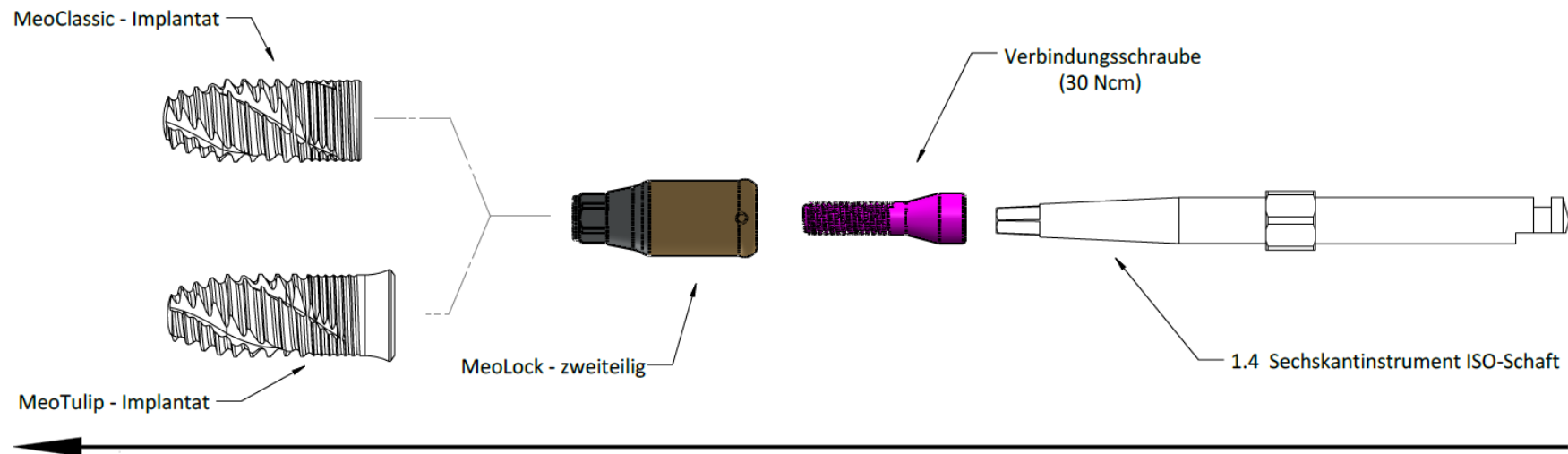

MEOLOCK - ZWEITEILIG – 1.4 SECHSKANTINSTRUMENT ISO-SCHAFT  
VERBINDUNGSSCHRAUBE (LILA)

## 5 MEOLOCK - ZWEITEILIG – 1.4 SECHSKANTINSTRUMENT HS/RS

### • FUNKTIONSDARSTELLUNG •

mit Verbindungsschraube (lila)

Produktbe- schreibung	REF	Verbindungs- schraube (lila)
		A-007-055055
1.4 Sechskantinstrument HS/RS - 9.5mm	A-015-099023	✓
1.4 Sechskantinstrument HS/RS - 13.5mm	A-015-099025	✓
1.4 Sechskantinstrument HS/RS - 17.5mm	A-015-099025	✓

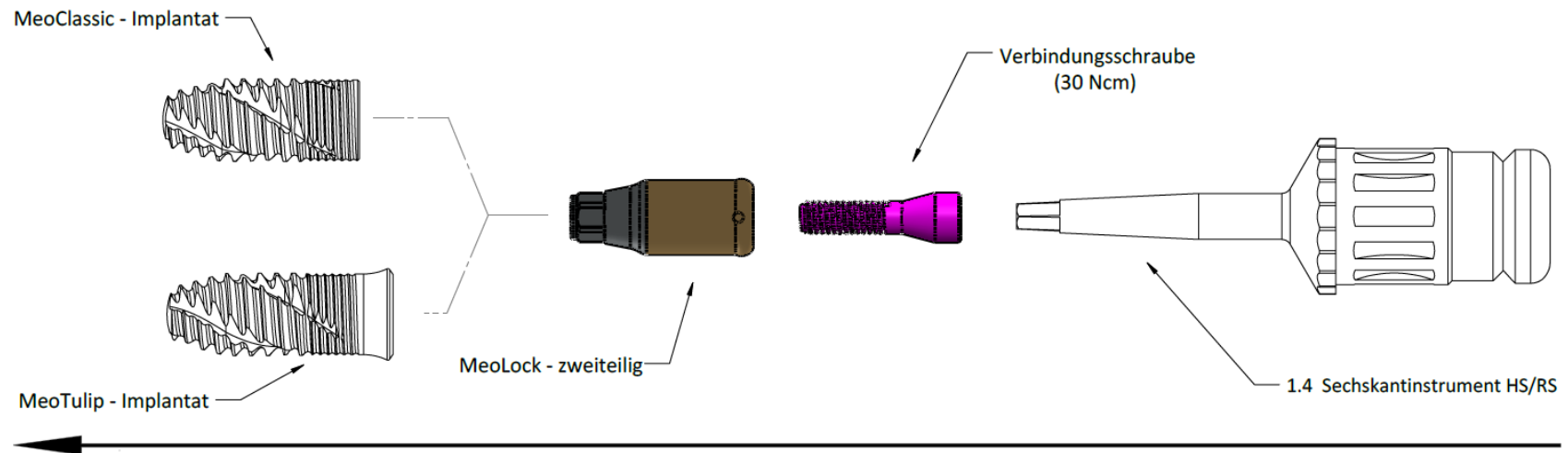

MEOLOCK - ZWEITEILIG – 1.4 SECHSKANTINSTRUMENT HS/RS  
 VERBINDUNGSSCHRAUBE (LILA)

## 6 MEOLOCK - ZWEITEILIG – MODELLANALOG STANDARD

Produktbeschreibung	REF	MeoLock - zweiteilig GH 1mm	MeoLock - zweiteilig GH 2mm	MeoLock - zweiteilig GH 3mm	MeoLock - zweiteilig GH 4mm	MeoLock - zweiteilig GH 5mm	MeoLock - zweiteilig GH 6mm
		S-007-504001	S-007-504002	S-007-504003	S-007-504004	S-007-504005	S-007-504006
Modellanalog Standard	A-006-380600	✓	✓	✓	✓	✓	✓

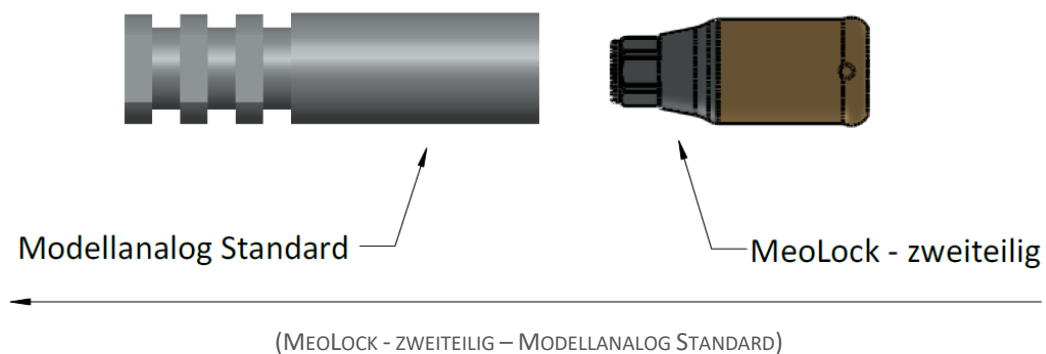



## 7 MEOLOCK - ZWEITEILIG – MODELLANALOG CAD/CAM

Produktbeschreibung	REF	MeoLock - zweiteilig GH 1mm	MeoLock - zweiteilig GH 2mm	MeoLock - zweiteilig GH 3mm	MeoLock - zweiteilig GH 4mm	MeoLock - zweiteilig GH 5mm	MeoLock - zweiteilig GH 6mm
		S-007-504001	S-007-504002	S-007-504003	S-007-504004	S-007-504005	S-007-504006
Modellanalog CAD/CAM	A-006-100200	✓	✓	✓	✓	✓	✓

